

CUBES INTERSTITIELS

CENTRE CULTUREL

PLAN MASSE

INSERTION
CONTINUITÉ
JARDIN

1:500

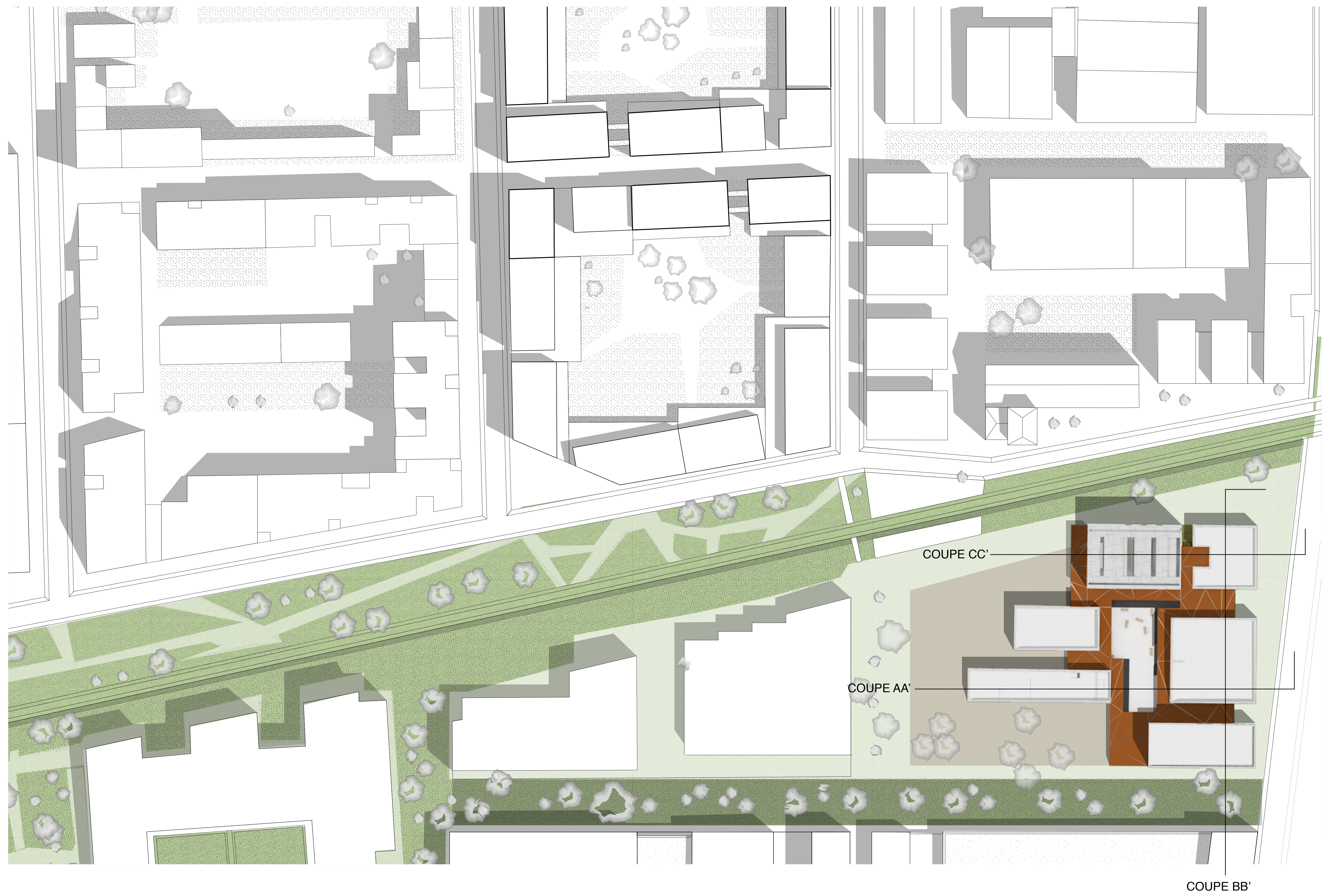
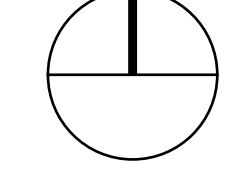

COUPES

INTEGRATION
INTERSTICES
CONTRASTE

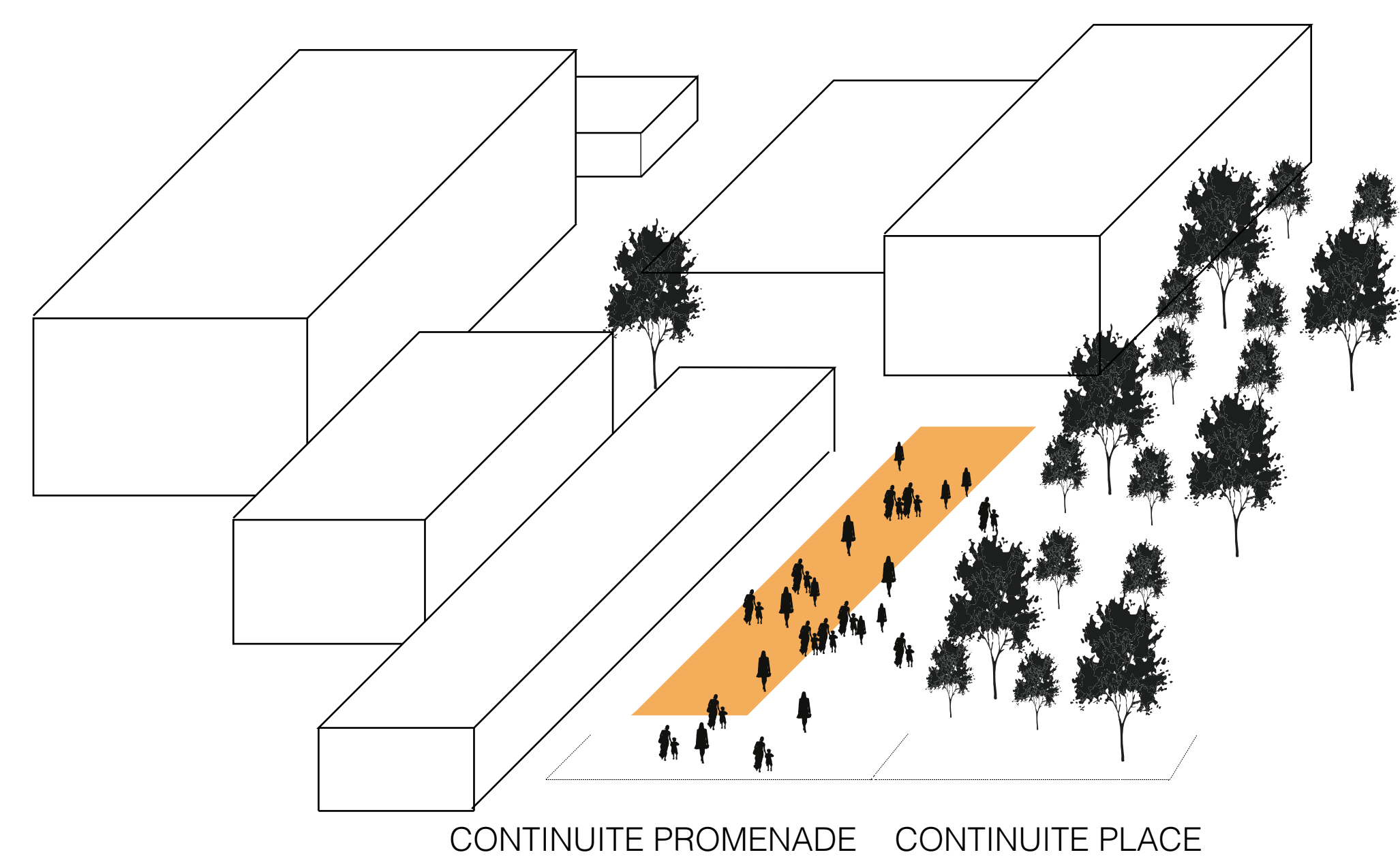

INTENTIONS URBAINES



COUPE AA' 1:200
GRAND FOYER - ECOLE

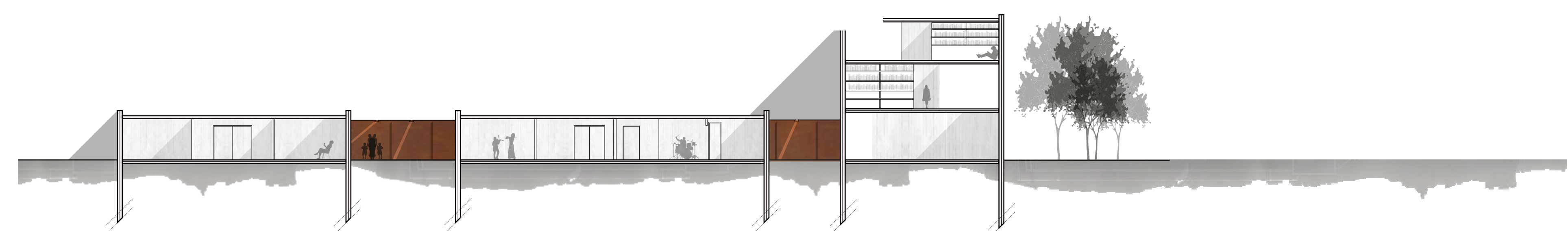

COUPE BB' 1:200
BIBLIOTHEQUE - ECOLE - LOGES

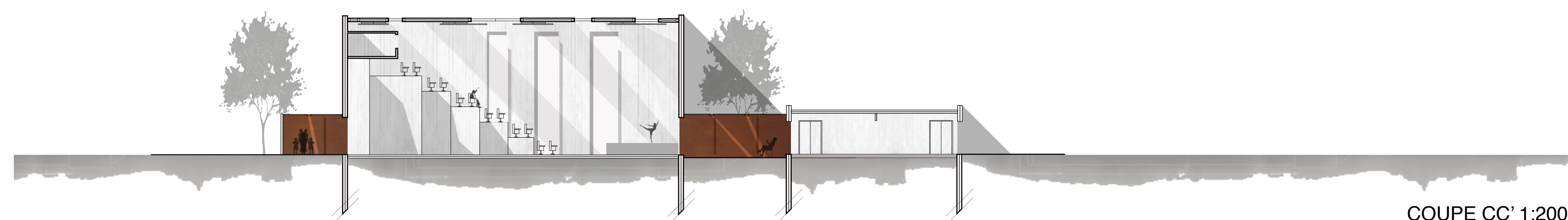

COUPE CC' 1:200
SALLE POLYVALENTE - LOGES



ELEVATION DE LA PLACE / OUEST
1:500



ELEVATION DU TRAM / NORD
1:500

CUBES INTERSTITIELS

CENTRE CULTUREL

ECLATER LES FONCTIONS

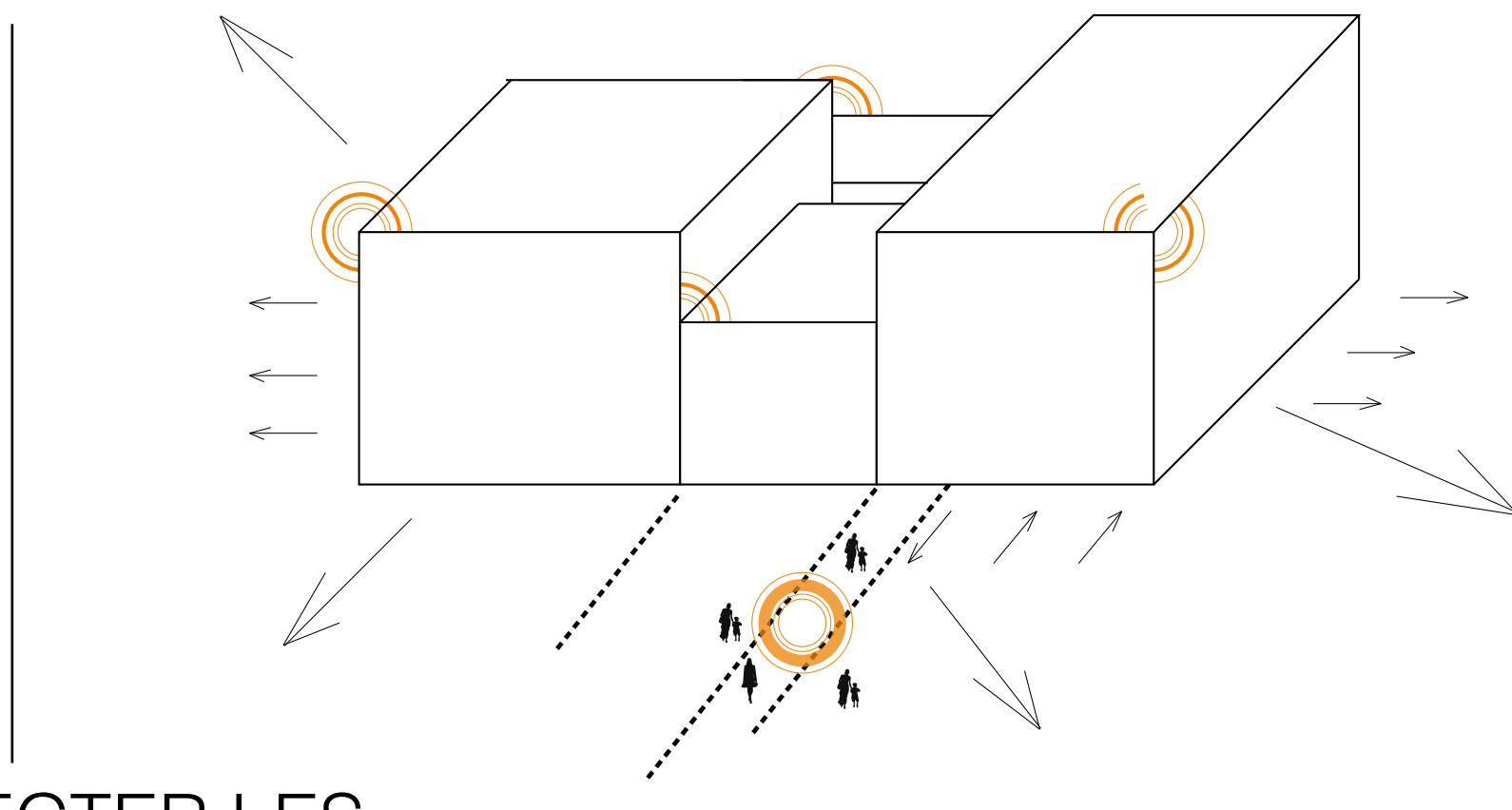

CONNECTER LES FONCTIONS

INTERACTIONS

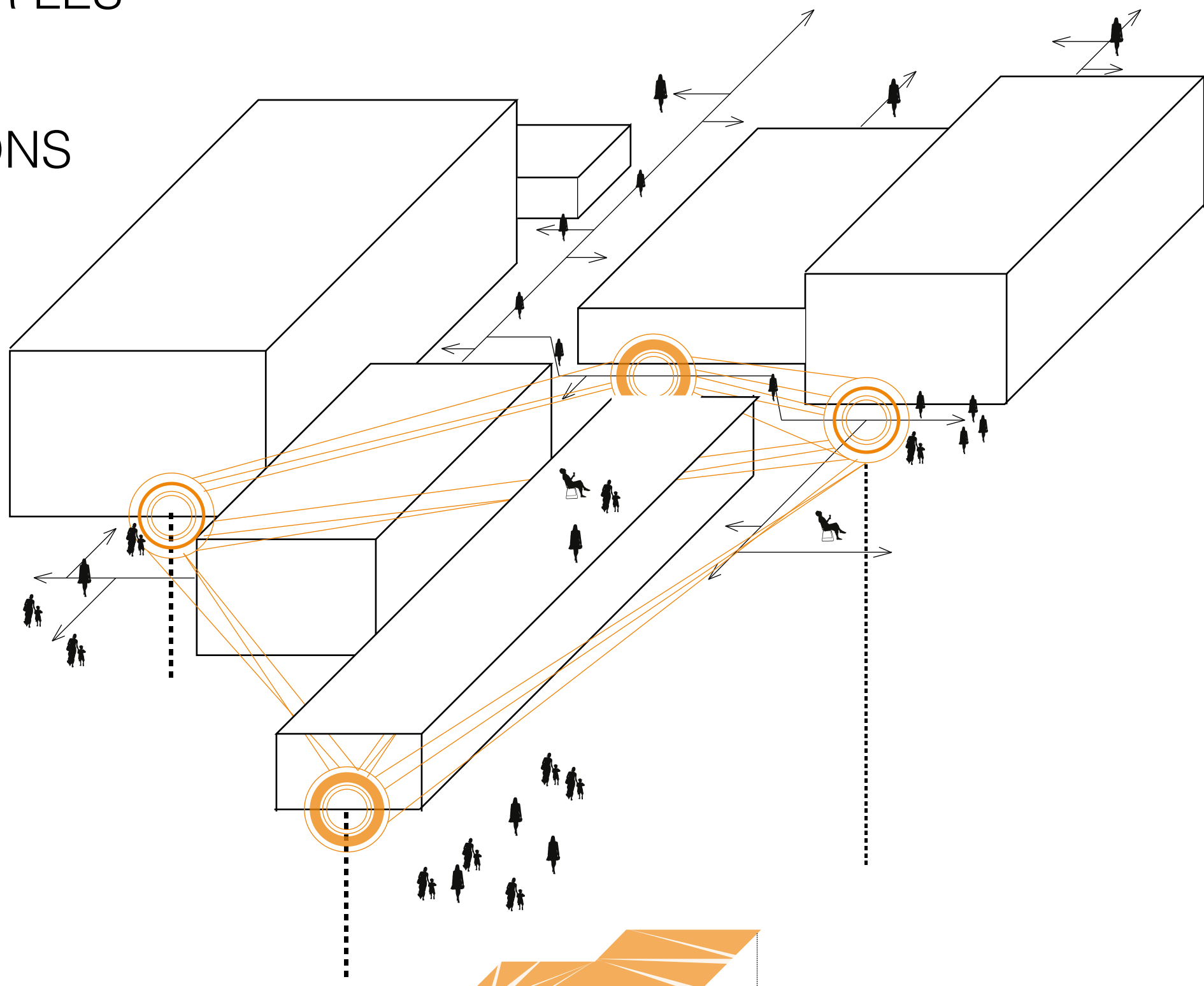

RELIER
PROTEGER
GUIDER

LUMIERE
&
PARCOURS

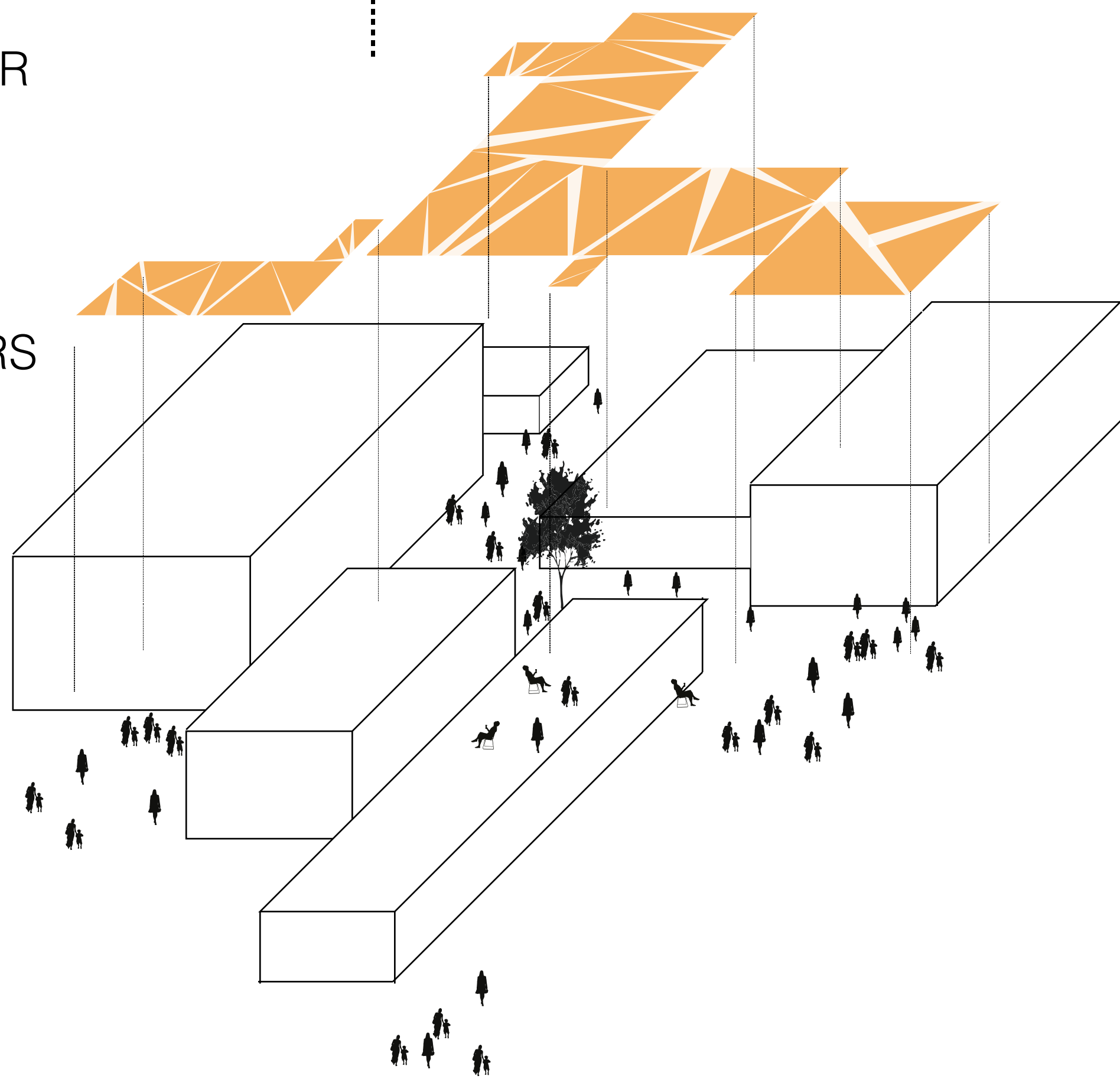

ESPACES INTERSTITIELS
CONNECTES ET EN
DIALOGUE

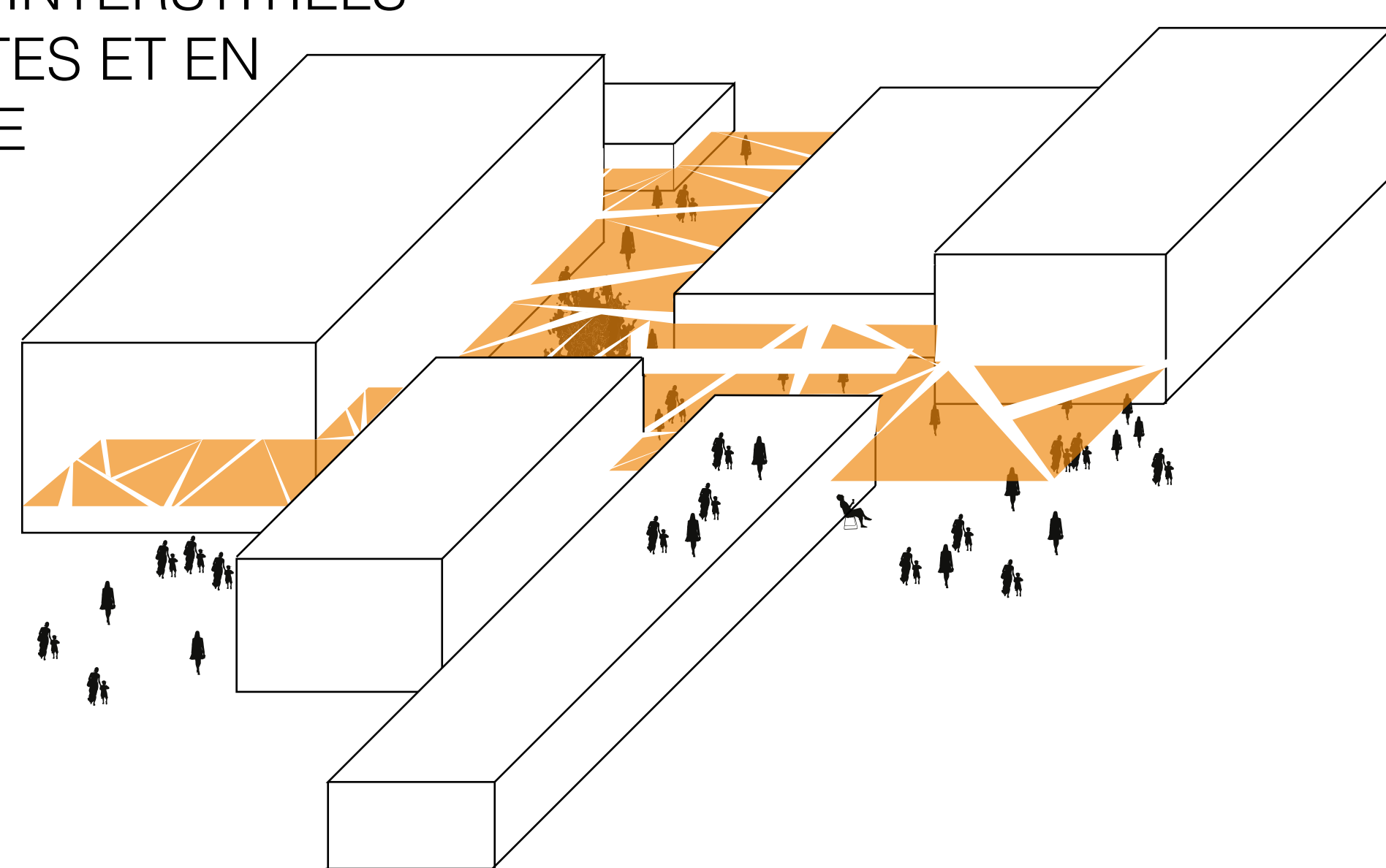

PERSPECTIVE D'ENTREE
HAUTEUR
GUIDER



PERSPECTIVE LOGE
CADER
LE REGARD

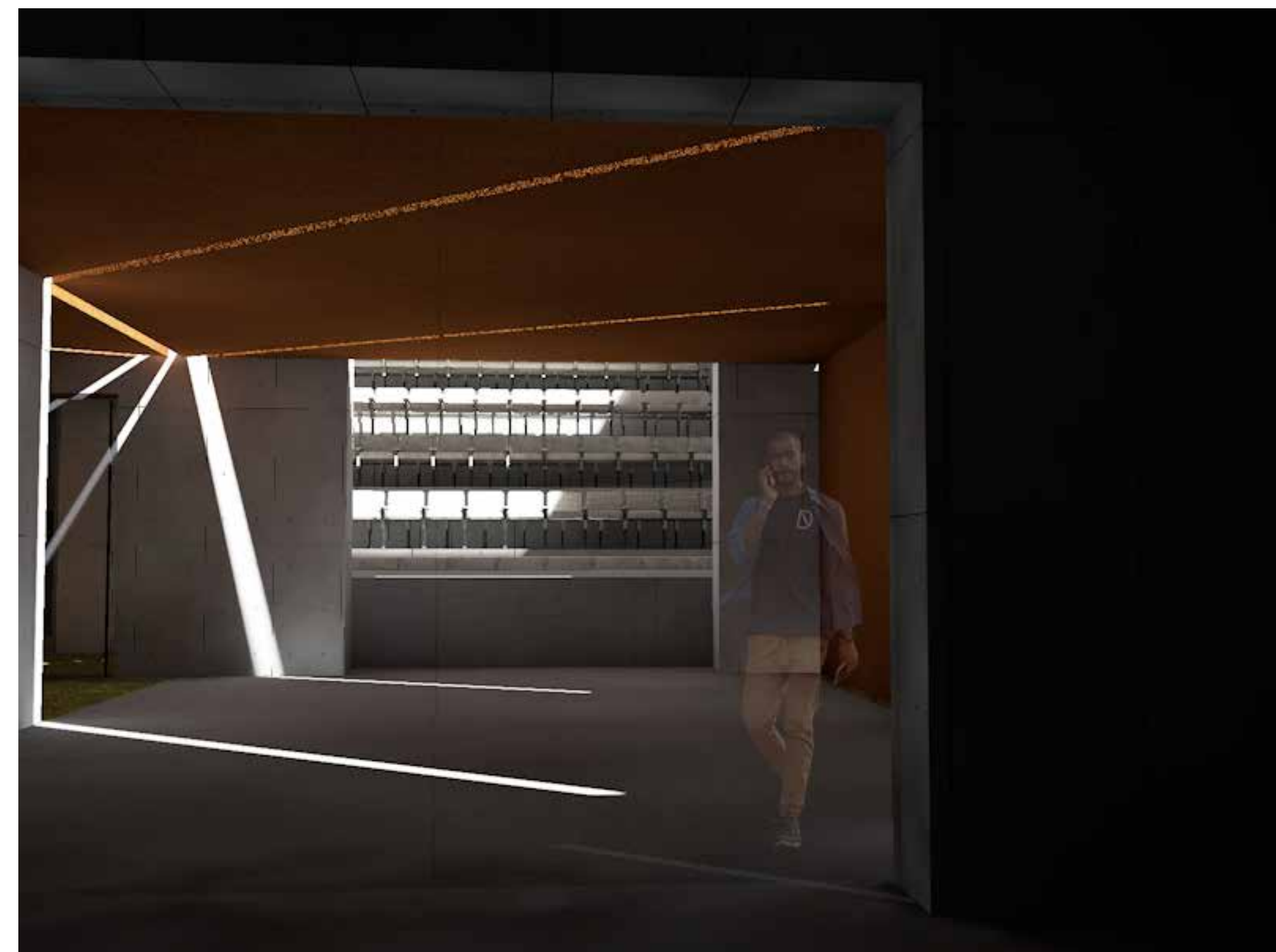

PERSPECTIVE PREAU
LUMIERE

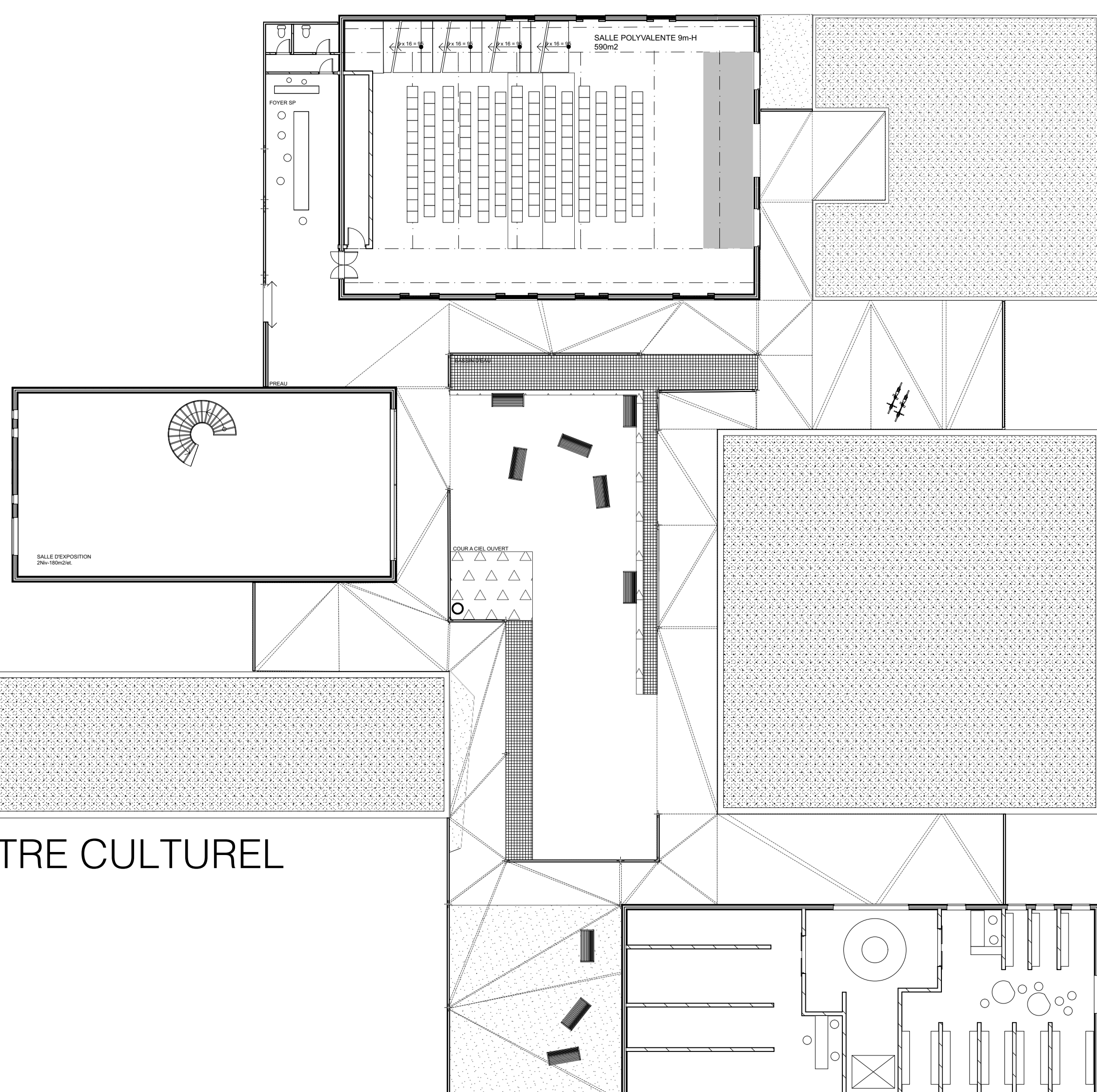

PLAN CENTRE CULTUREL
RDC 1:200

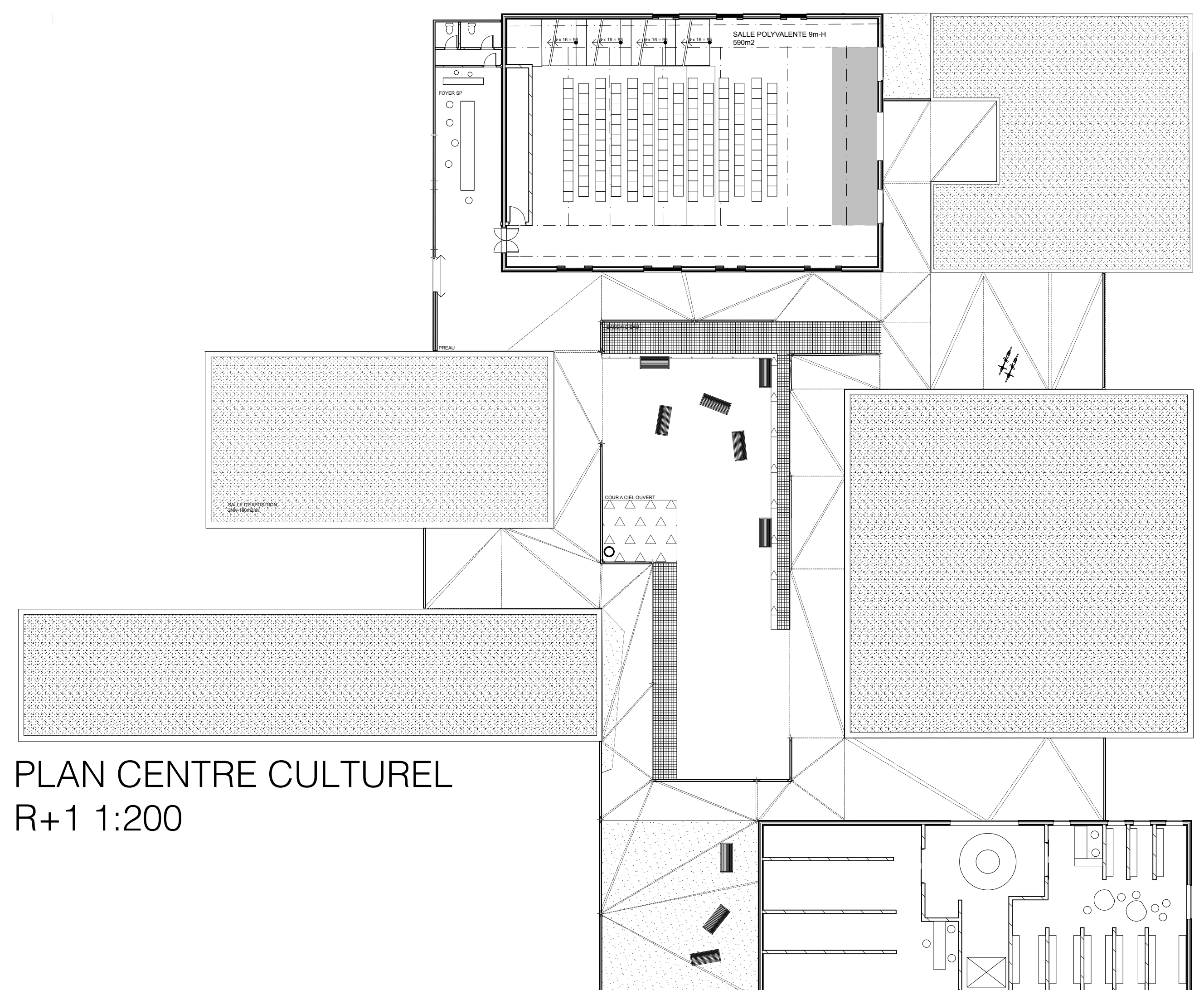
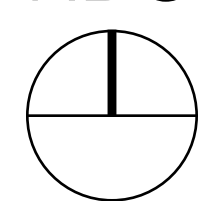

PLAN CENTRE CULTUREL
R+1 1:200

CUBES INTERSTITIELS

CENTRE CULTUREL



FACADE SUD / VUE DE LA PROMENADE
1:100

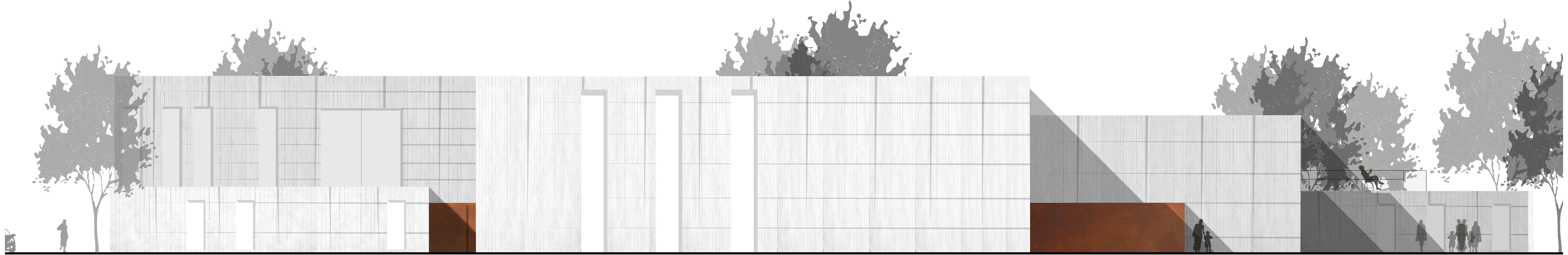

FACADE NORD / VUE DU TRAM
1:100



FACADE EST / VUE DE LA RUE
1:100



FACADE OUEST VUE DE LA PLACE
1:100

FACADE EST / RUE

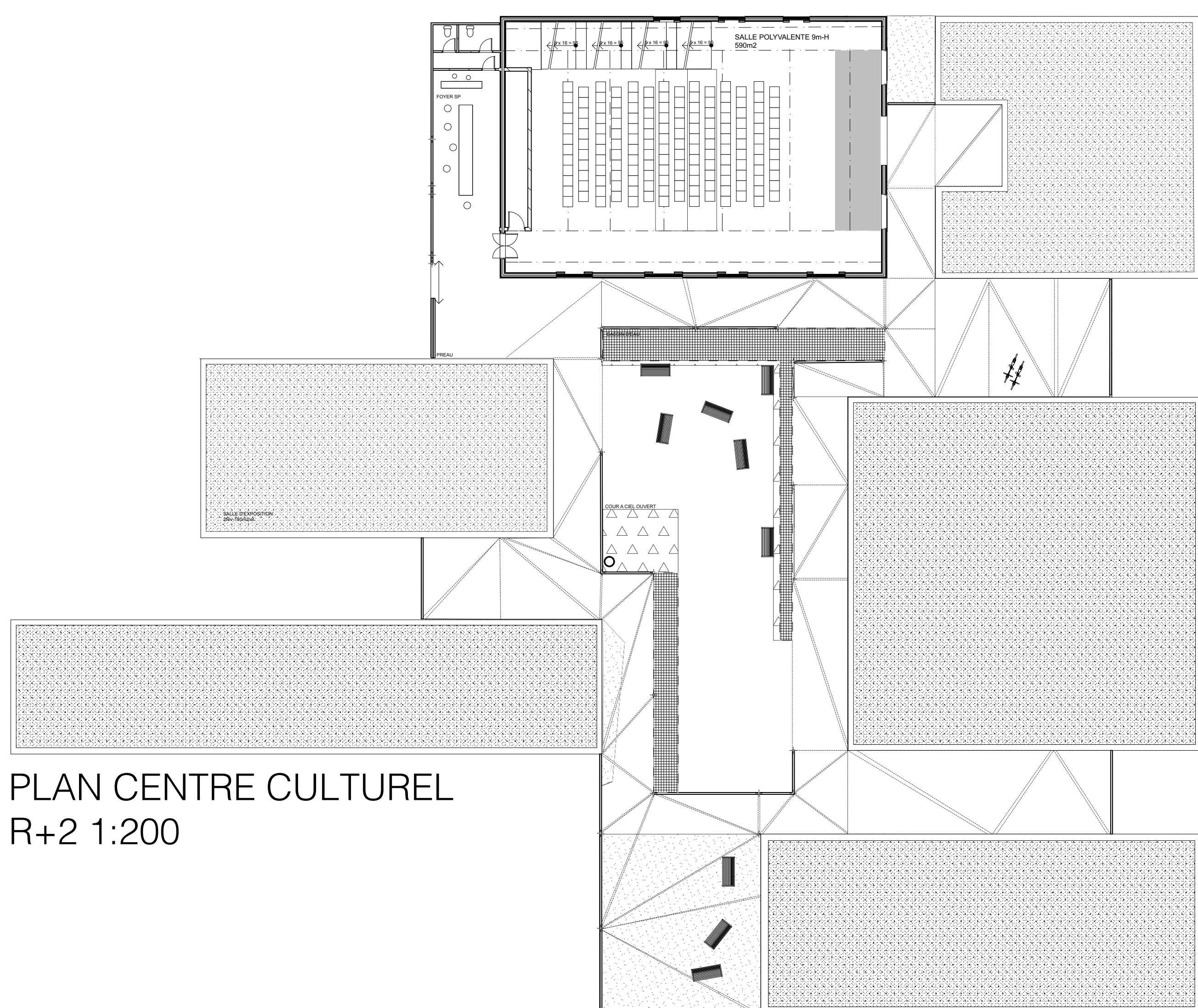

PLAN CENTRE CULTUREL
R+2 1:200

FACADE NORD / TRAM

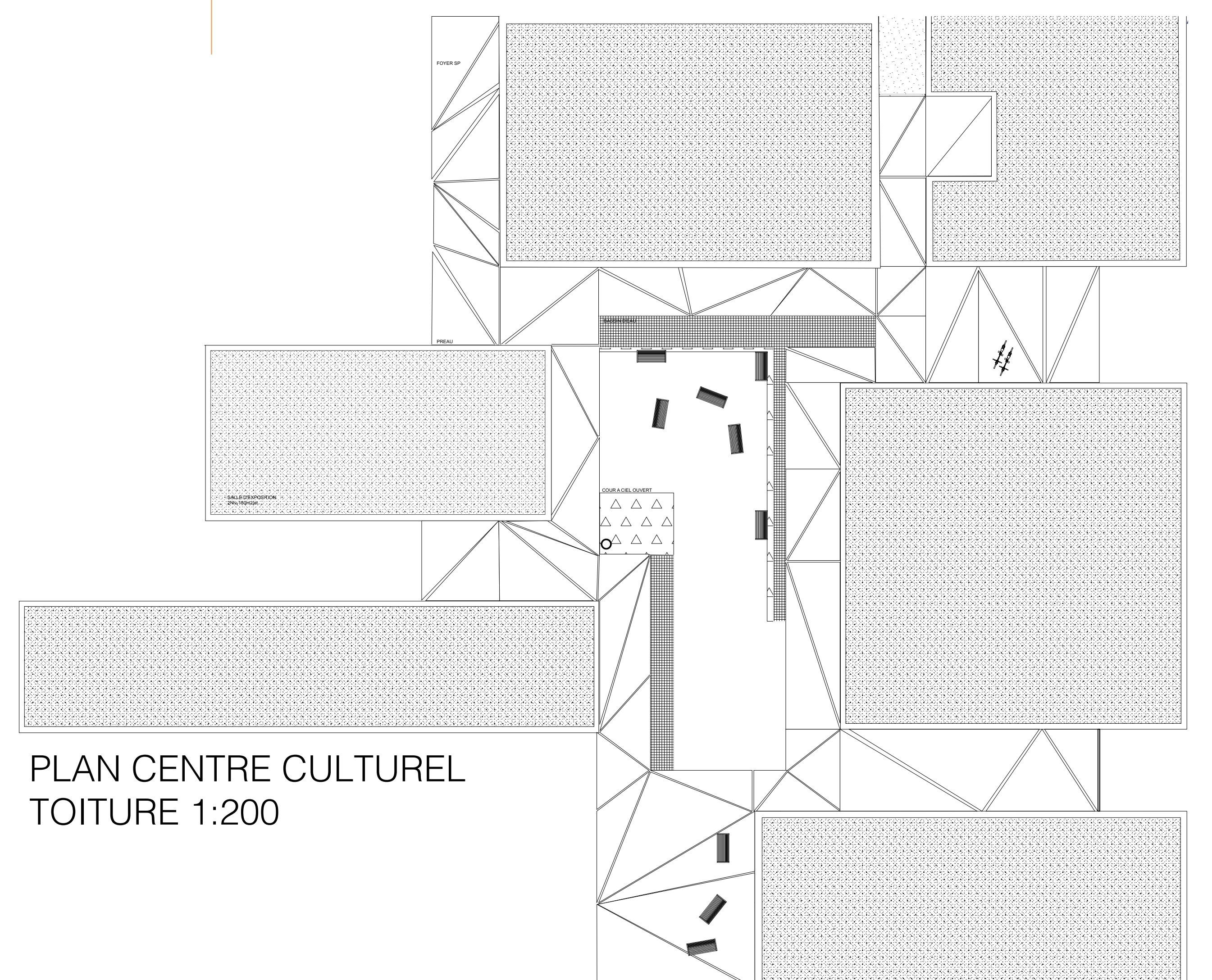

PLAN CENTRE CULTUREL
TOITURE 1:200

FACADE SUD / PROMENADE

FACADE OUEST / PLACE

CUBES INTERSTITIELS

CENTRE CULTUREL

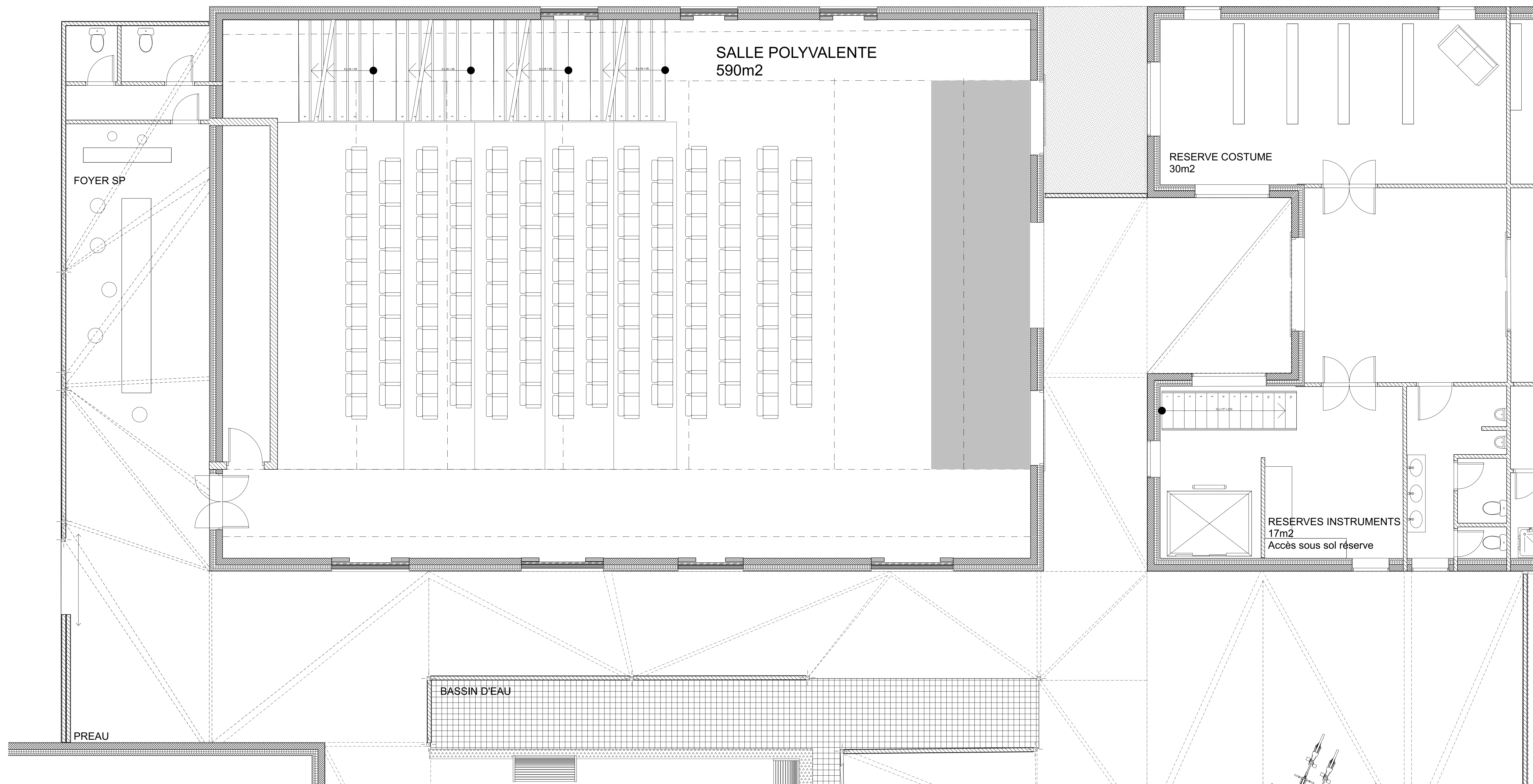

PLAN SALLE
POLYVALENTE
COUPE LONGITUDINALE
PERSPECTIVES

SALLE POLYVALENTE

1:50

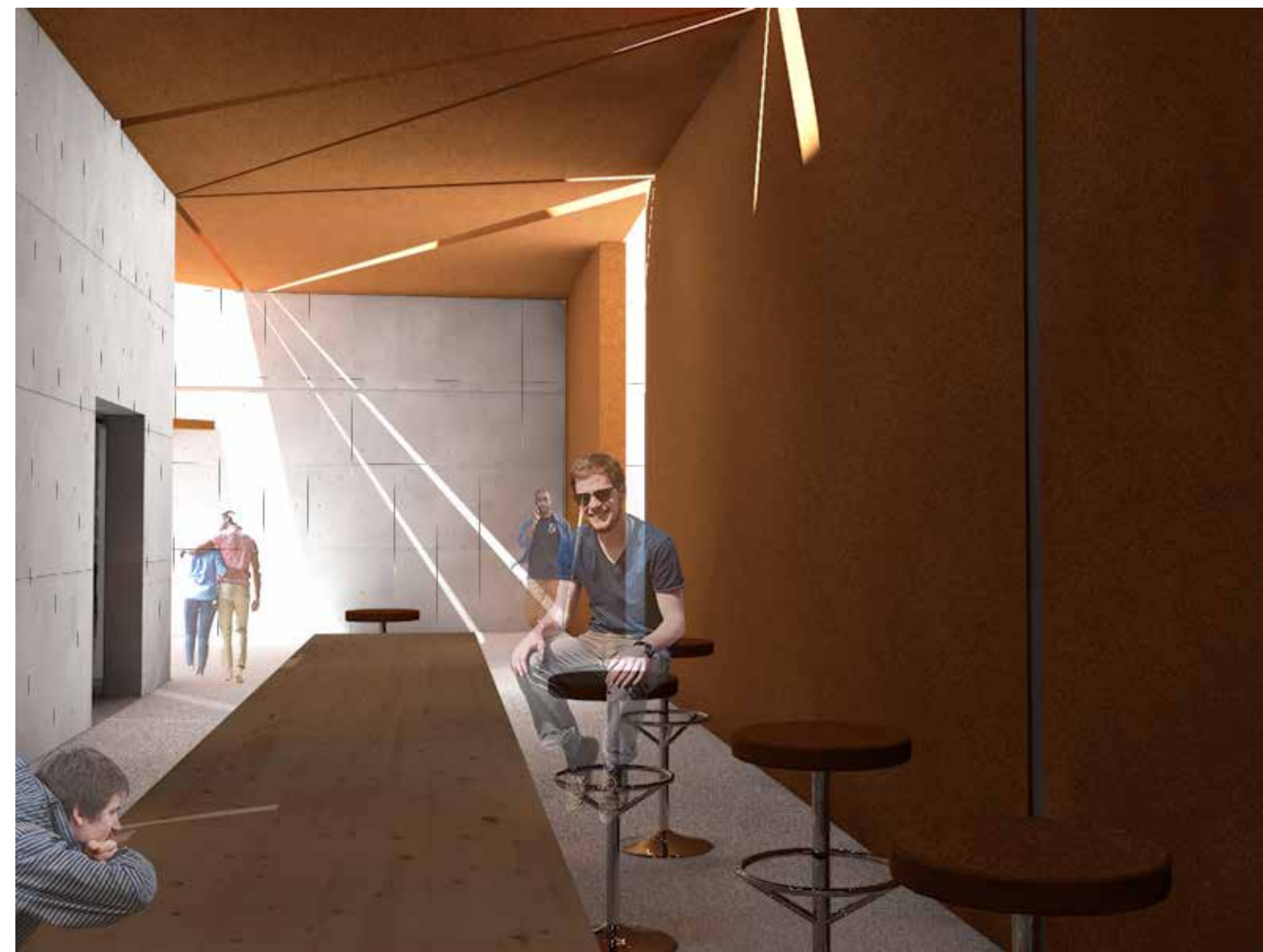
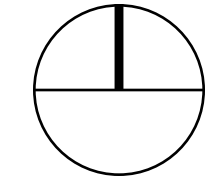

PERSPECTIVE ENTREE
FOYER DE LA SALLE



PERSPECTIVE ENTREE
SALLE POLYVALENTE

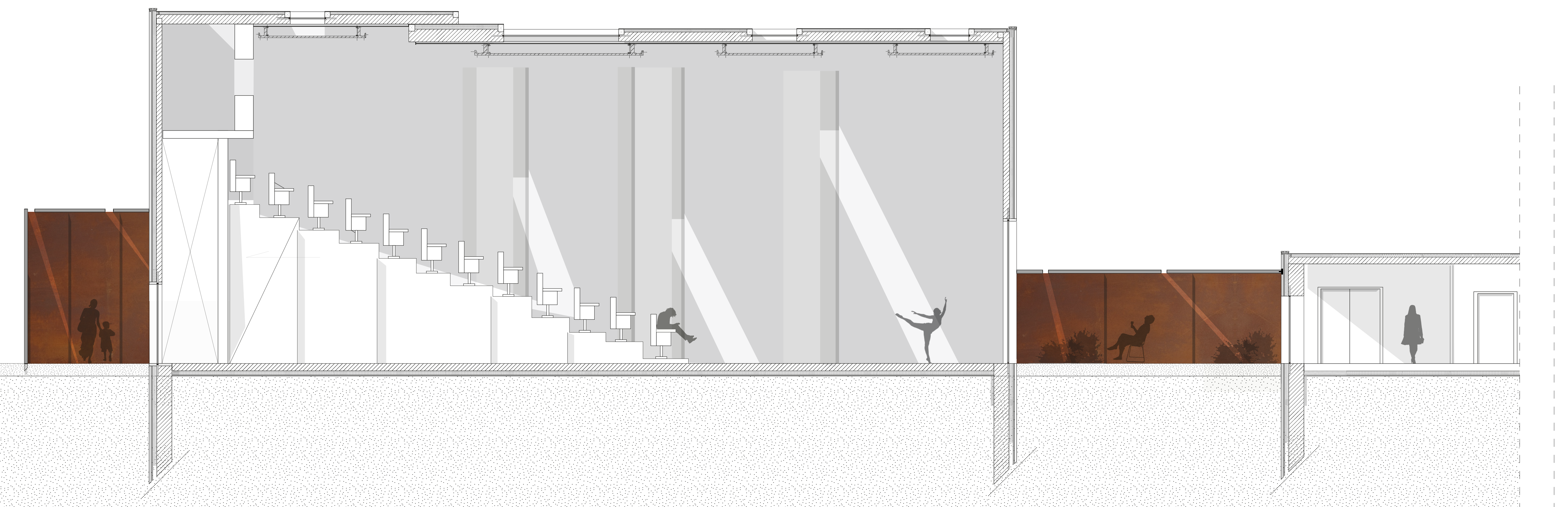

CUBES INTERSTITIELS

CENTRE CULTUREL

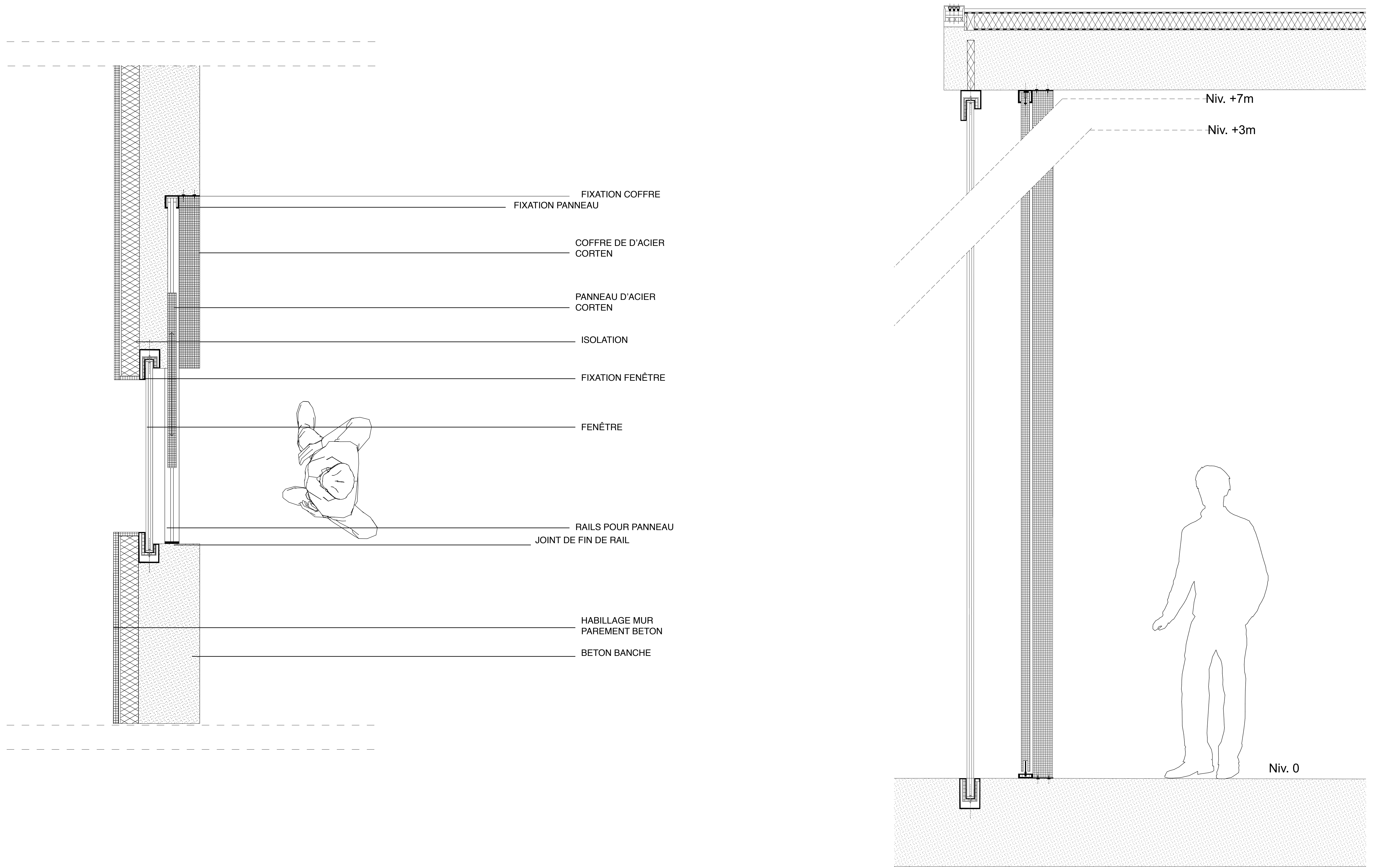

DETAIL VOILET ACIER CORTEN COUPE TRANSVERSALE PERSPECTIVES

SALLE POLYVALENTE
1:50 COUPE
1:10 DETAIL



PERSPECTIVE ECOLE DE
MUSIQUE SOUS PREAU



PERSPECTIVE ECOLE DE
MUSIQUE SOUS PREAU

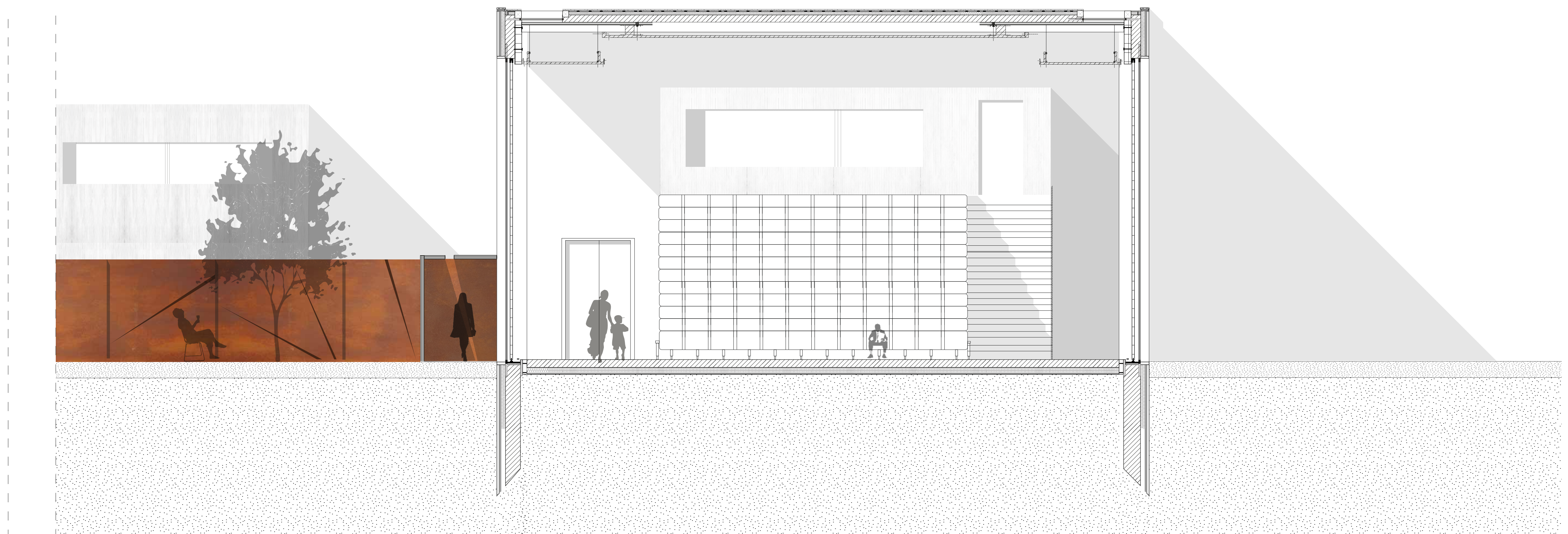

CUBES INTERSTITIELS

CENTRE CULTUREL

PLAN / COUPE DETAIL
ESPACE PREAU

1:10

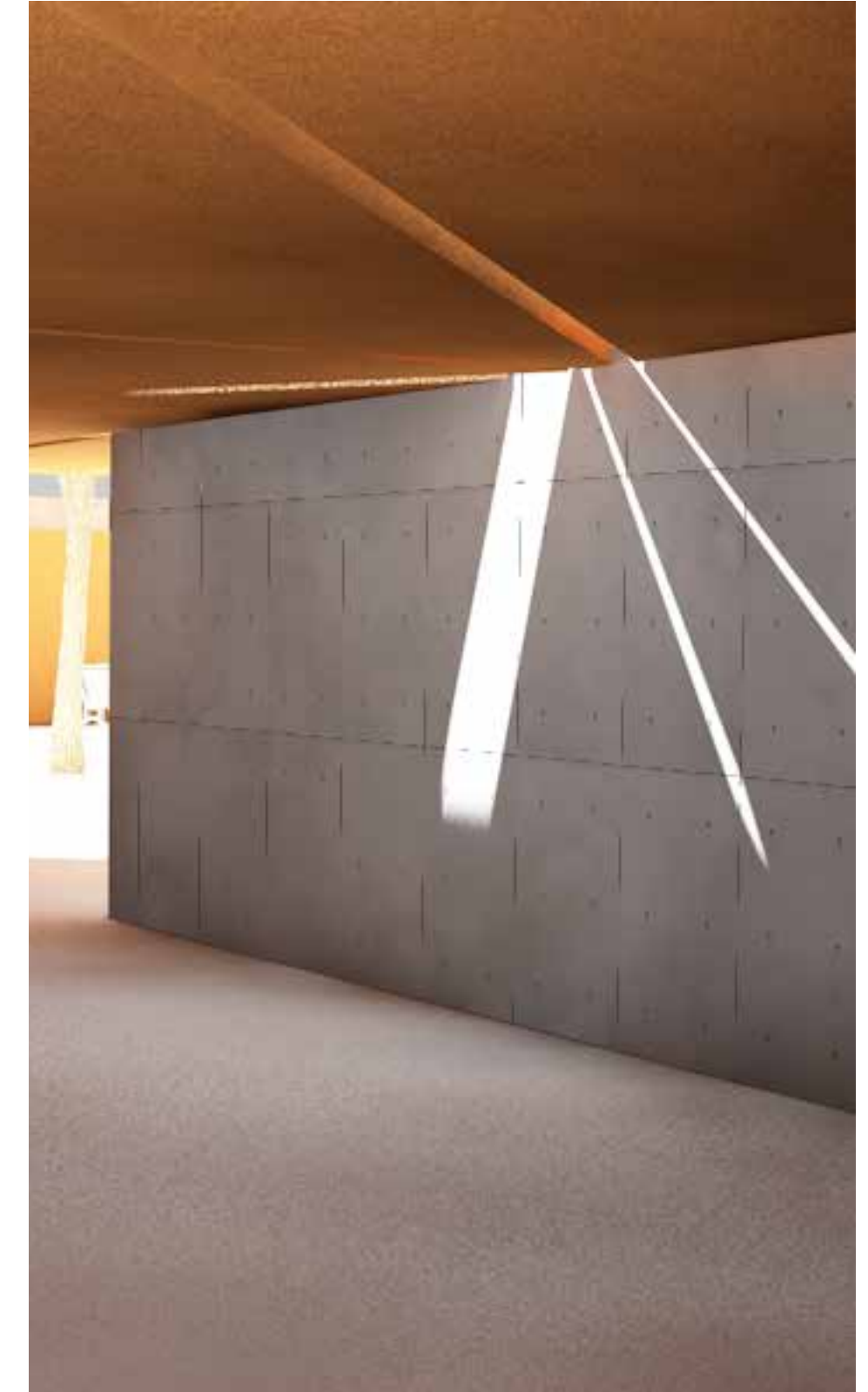
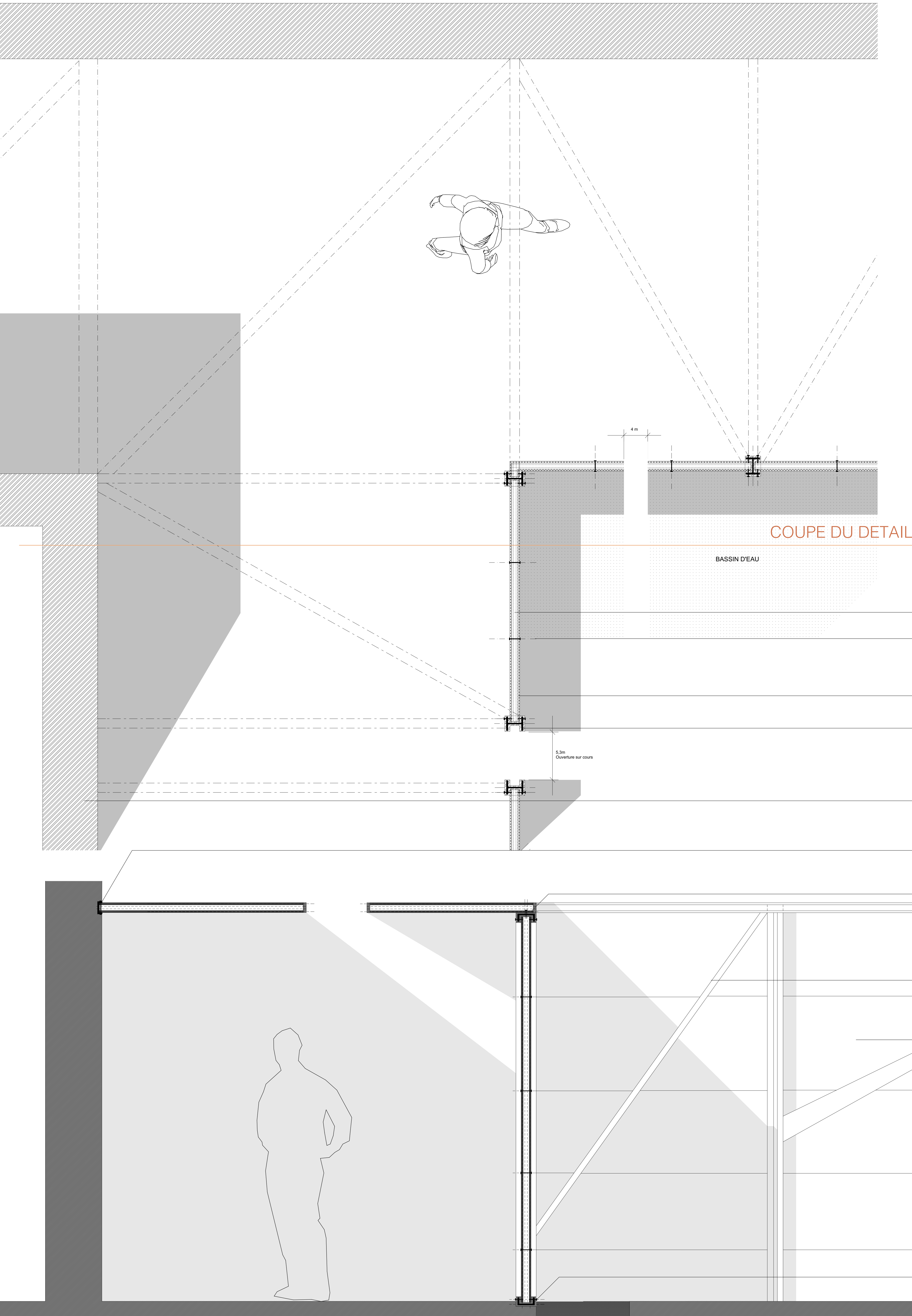
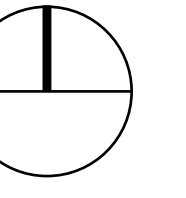

PERSPECTIVE ENTREE
FOYER DE LA SALLE
GUIDER LE PARCOURS
JEUX DE LUMIERE

COUPE DU DETAIL

BASSIN D'EAU

CABLE METALLIQUE
STRUCTURE PANNEAU
FIXATION PLAQUE
ENTRE ELLE

PLAQUE ACIER
CORTEN
PREFABRIQUEE
POTEAU EN I DE
SOUTIEN METALLIQUE

BETON BANCHE

ARMATURE POUR
PLAQUE D'ACIER
CORTEN
PERCEMENT DANS LE
MUR

ARMATURE LIANT
LES DEUX PLAQUES
D'ACIER CORTEN

FAILLE DE VIDE ENTRE
LES DEUX PLAQUES

TRACE DU
CALPINAGE

FONDATION DE LA
STRUCTURE

CC (6)

REFERENCES

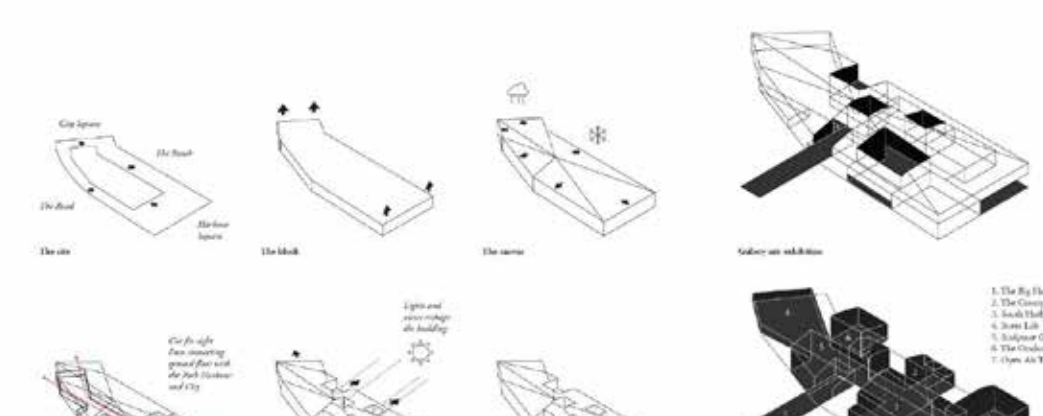
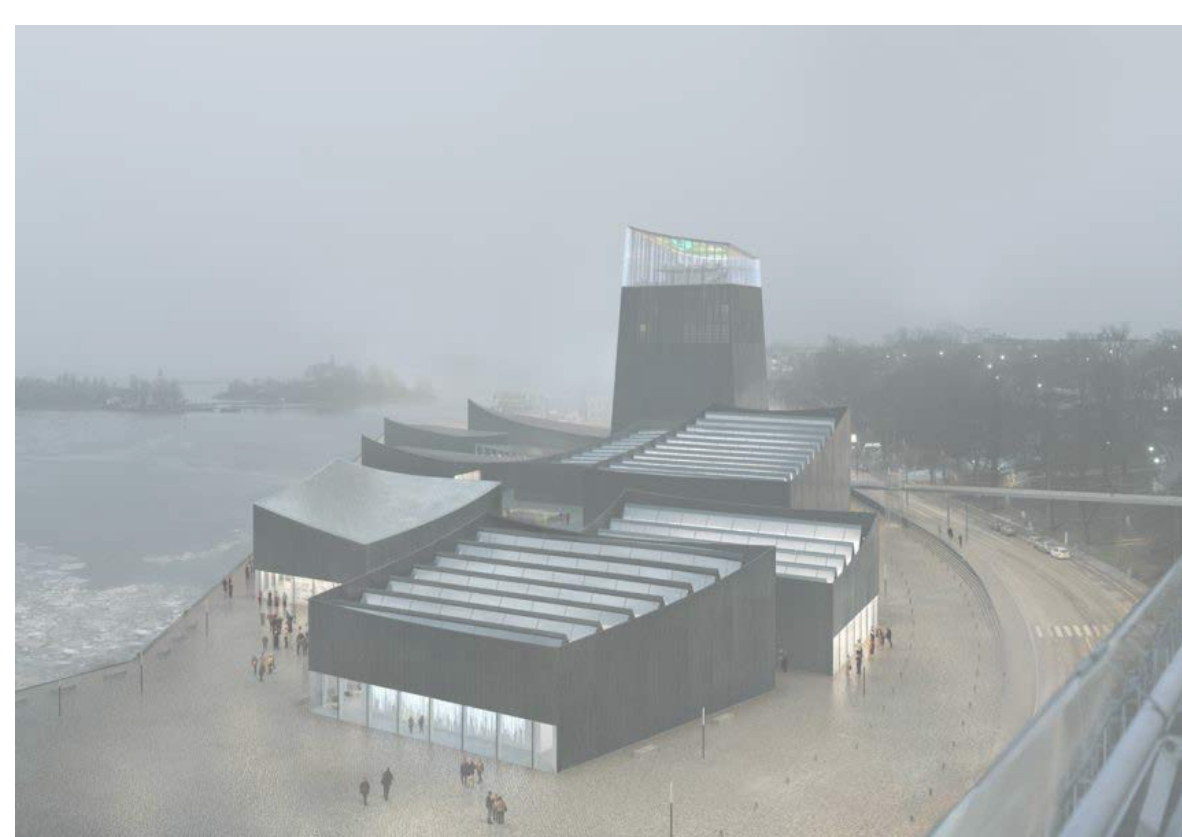

FRAGMENTER
POINT DE REPERE
INTERSTICE ENTRE
BATIMENT

GUGGENHEIM HELSINKI - MOREAU KUSUNOKI



FRAGMENTER
REFERER
ECLAIRER
GUIDER

BUREAU GREAT JAMES STREET
AMRYS ARCHITECTE

FACADE EST / RUE